

innovations for life



V00140325



GEO-ENS0/R45

DE - Handbuch
EN - Manual

FR - Manuel
IT - Manuale

ES - Manual











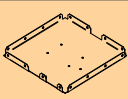

DE: LIEFERUMFANG

EN: SCOPE OF DELIVERY

FR: VOLUME DE LIVRAISON

IT: CONTENUTO DELLA CONSEGNA

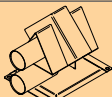
ES: VOLUMEN DE ENTREGA

Symbol	Art.Nr.	Stk./pcs.
	(A) 2-100.99.205	2
	(B) 2-100.99.231	1
	(C) 2-100.99.211	1
	(D) 2-100.99.202	1
	(E) 2-100.99.212	1
	(F) M8x20	26
	(G) M8	24
	(H) M6x20 4-900.10.134	2
	(I) M6	2
	(J) 1-100.15.660	1
	(K) 1-100.15.619	2
	(L) 2-100.60.900	1

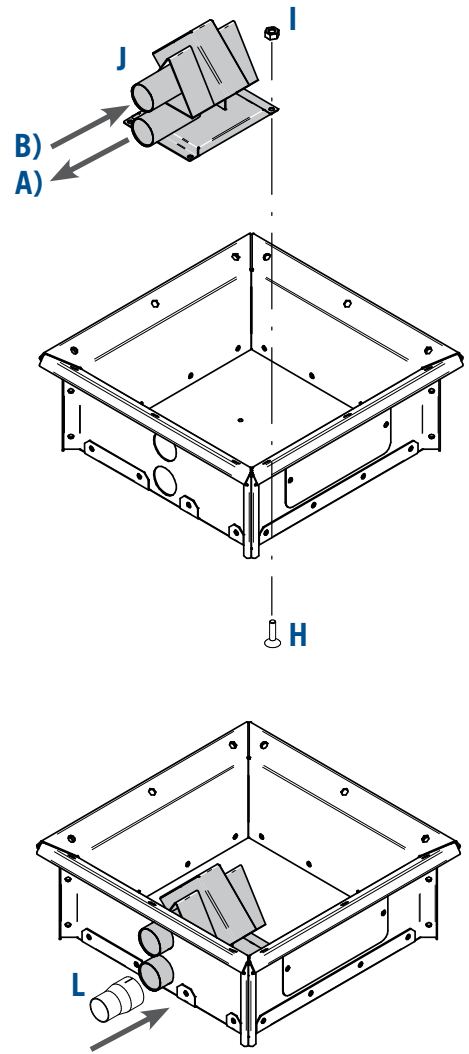
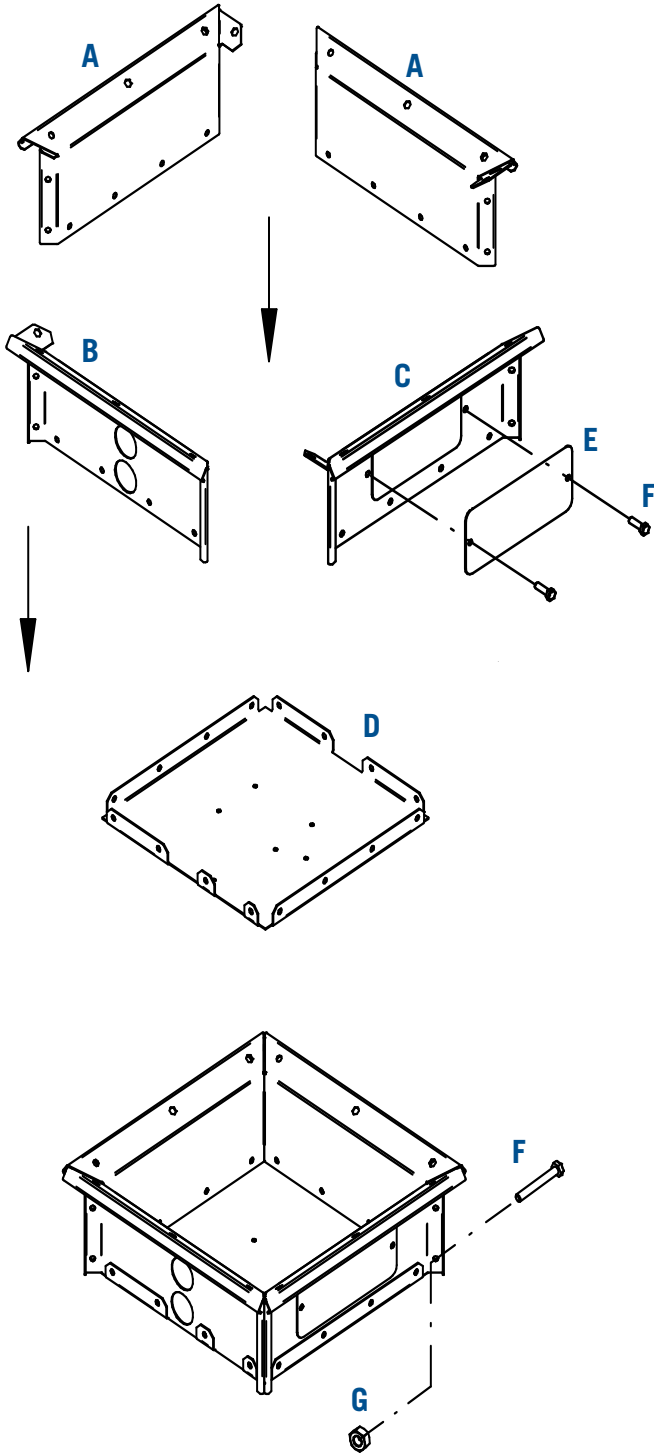

- A)**
 DE: Anschluss Pelletansaugschlauch.
 EN: Connection pellets suction hose.
 FR: Branchement tuyau d'aspiration de pellets.
 IT: Collegamento tubo d'aspirazione del pellet.
 ES: Conexión manguera de aspiración de pellets.
- B)**
 DE: Anschluss Rückluftschlauch.
 EN: Connection air return hose.
 FR: Branchement tuyau de retour d'air.
 IT: Collegamento tubo di ritorno aria.
 ES: Conexión manguera de retorno del aire.

Technische Änderungen und Druckfehler vorbehalten. Alle Angaben ohne Gewähr. / Specifications subject to change without notice. / Toutes indications sous réserve de modifications techniques. / Con riserva di cambiamenti tecnici.

innovations for life



GEOplast Kunststofftechnik Ges.m.b.H.

Bahnstrasse 45 • A-2604 Theresienfeld

T.: +43 (0) 2622 / 65 242 • F.: +43 (0) 2622 / 65 242- 17

e-mail: kunststoff@geoplast.com • www.geoplast.com